

P/N: FAPE300525

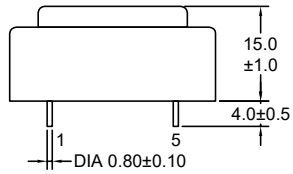

Outline Dimensions(Unit:mm)



Front View

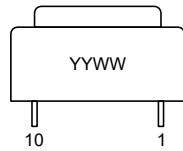

Side View

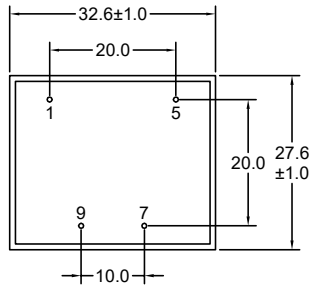

Bottom View

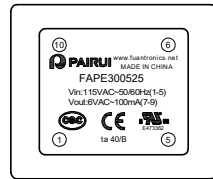

Top View

Note:

1.Remove Pins 2,3,4,6,8,10.

Wave Soldering

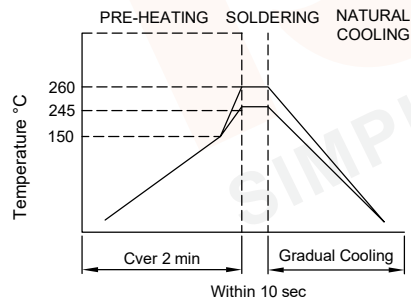

Note:

- 1.Never Contact the ceramic with the iron tip;
- 2.1.0mm tip diameter(max).

Electronical Schematic

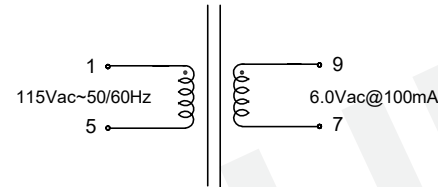

Electrical Characteristics

Input 115Vac 60Hz to 1-5 :  
Excitation current(Ix):18mA Max.  
Output: Vo=9.94Vac Typ(No-load).  
VL=6.0Vac±5%(@100mA).  
Hi-Pot: Pri-Sec:4000VAC/5mA/60Second.

General Properties

Operating Temperature:-25°C to +40°C.  
Storage Temperature:-25°C to +85°C.  
Insulation Class: B.

				Tianchang Fuan Electronic Co Ltd www.fuantronics.net TEL: +86-550-7814888 FAX: +86-550-7831133		Make: Qiumei.Liu Checked: Beson. zhan Approved: Anson. zhan	<b>DRAWING TITLE</b> 0.60W Encapsulated Transformer For EI30*5.5,115VAC Input 50/60Hz Material Number: A223005XS120	Customer Name: Document/Rev: 00 Specification Sheet: 1 of 3 Date of Recognition: Jan./02/2020
REV	DESCRIPTION	APPD	DATE		Tolerances unless otherwise specified: (.X)±0.50 (XX)±0.25 Unit of measurement: mm			

P/N: FAPE300525

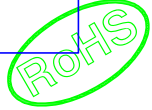

List of UL Certificate:

No.	Part Name	Mat'l Description	Supplier	UL Number
1	Bobbin	EI30*5/PBT(Black)	Chang Chun Plastics Co Ltd	E59481
2	Case	CASE-EI30*5/PA66(Orange)	Zhejiang Juner New Materials Co Ltd	E204321
3	Copper wire	2UEW-F/155C	Elektrisola Hangzhou Co Ltd	258243
4	Core	Lamination	Ta Yea Steel Industry Co Ltd	N/A
5	Epoxy	PU552(Black)	Wevo-Chemle Gmbh	E108835
6				

Packaging Specification:

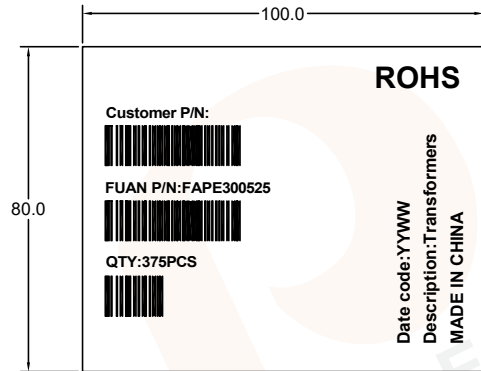

Label of outer

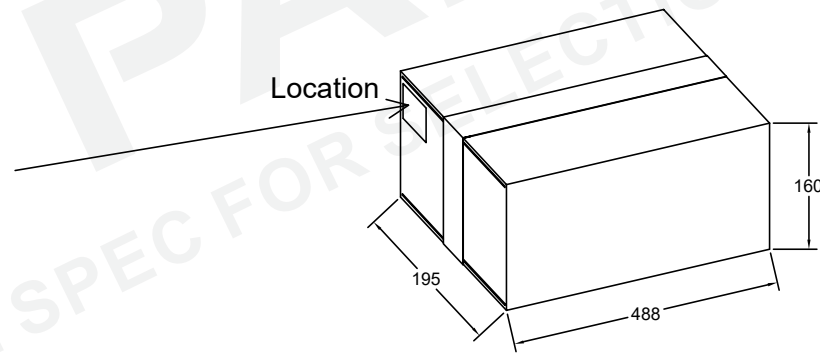

put the label on the top left corner of one of the carton sides

				Tianchang Fuan Electronic Co Ltd www.fuantronics.net TEL: +86-550-7814888 FAX: +86-550-7831133	 Tolerances unless otherwise specified: (.X)±0.50 (XX)±0.25 Unit of measurement: mm	Make: Qiumei.Liu Checked: Beson. zhan Approved: Anson. zhan	<b>DRAWING TITLE</b> 0.60W Encapsulated Transformer For EI30*5.5,115VAC Input 50/60Hz Material Number: A223005XS120	Customer Name: Document/Rev: 00 Specification Sheet: 2 of 3 Date of Recognition: Jan./02/2020
REV	DESCRIPTION	APPD	DATE					

P/N: FAPE300525

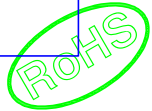

Packing Method:

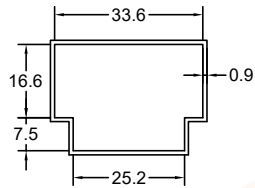
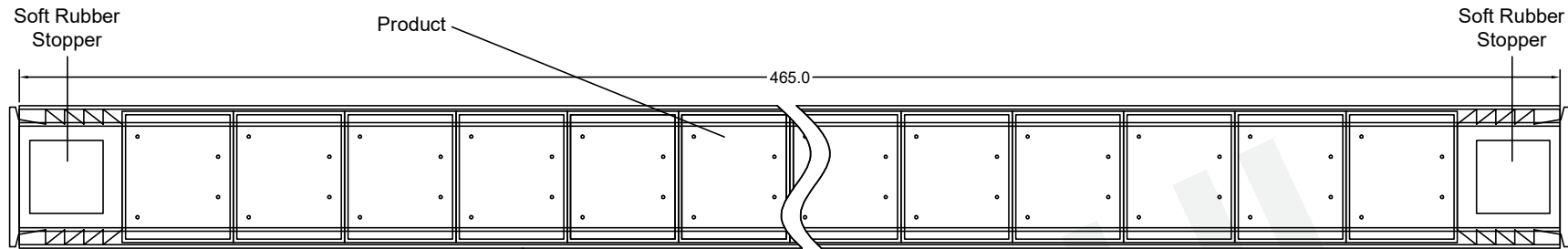

Size of packaging tube:  
465mm\*35.4mm\*25.9mm  
(Length \* Width \* Height)

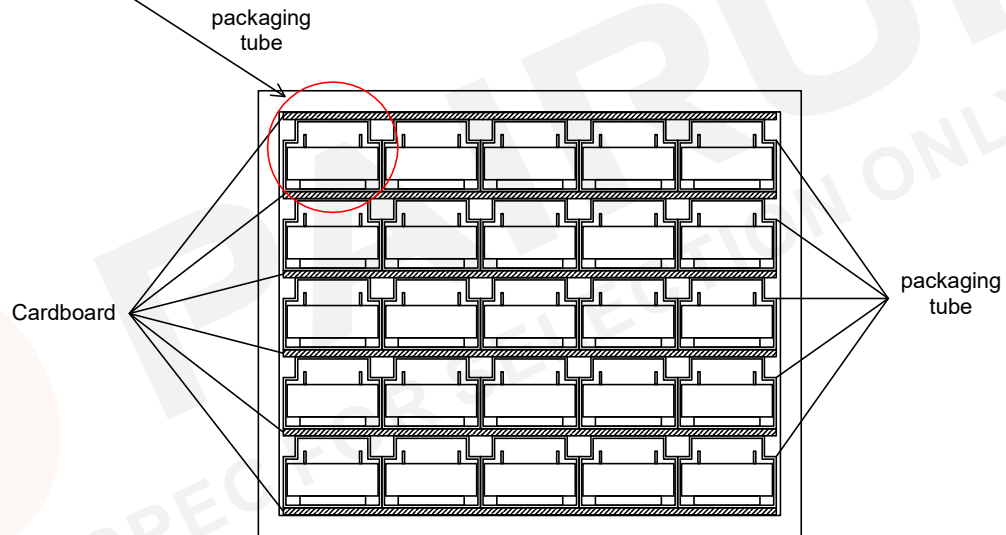

Carton Box Side View

Layer/Carton	Quantity/Tube (pcs)	Quantity/Carton (pcs)	Net weight (g/pc)	Gross weight (g/tube)	Tubes/carton (pcs)	Total weight (kg)	box size Dimensions (mm)
5.0	15.0	375.0	43.0	71.76	25.00	18.67	488*195*160

REV	DESCRIPTION	APPD	DATE

Tianchang Fuan Electronic Co Ltd  
www.fuantronics.net  
TEL: +86-550-7814888  
FAX: +86-550-7831133



Tolerances unless otherwise specified:  
(.X)±0.50 (.XX)±0.25  
Unit of measurement: mm

Make: Qiumei.Liu  
Checked: Beson. zhan  
Approved: Anson. zhan

**DRAWING TITLE**  
0.60W Encapsulated Transformer  
For EI30\*5.5,115VAC Input 50/60Hz  
Material Number: A223005XS120

Customer Name:  
Document/Rev: 00  
Specification Sheet: 3 of 3  
Date of Recognition: Jan./02/2020